



Wireless Communication Modem HG 761

Revision H (English)	Developed by: T.N.
Date: 04.09.1998	Author: RAD / SCH
Götting KG, Celler Str. 5, D-31275 Lehrte - Röddensen (Germany), Tel.: +49 (0) 51 36 / 80 96 -0, Fax: +49 (0) 51 36 / 80 96 -80, eMail: techdoc@goetting.de, Internet: www.goetting.de	

Contents

1	General System Description	6
1.1	Exclusion of Liability	6
1.2	Copyright.....	6
1.3	Connections	6
1.4	Front Panel Elements	7
1.5	High Frequency Antenna Cable	7
2	Hardware Configurations	8
2.1	Power Supply	8
2.2	Interfaces	8
2.2.1	RS 232 Interface	8
2.2.2	TTY Interface	9
2.2.3	RS 485 Interface	11
2.2.4	RS 422 Interface	11
2.2.5	Analog Interface	11
2.3	Transceiver	11
2.4	Board	12
2.5	Software Revisions	13
2.6	Available Variants of System HG 761	13
3	Software Versions	14
3.1	Software for transparent Data Transmission including Carrier Control HG 39720_AA	14
3.1.1	Introduction	14
3.1.2	Software Description.....	14
3.1.3	Data Buffer	15
3.1.4	CRC (Cyclic Redundancy Check)	15
3.1.4.1	Operation without CRC	15
3.1.4.2	Operation with CRC	15
3.1.5	Hardware-Handshake RTS/CTS.....	15
3.1.6	Command Mode	16
3.1.7	AT Commands.....	16
3.1.7.1	AT I	16
3.1.7.2	AT O.....	16
3.1.7.3	AT Sr?.....	16
3.1.7.4	AT Sr=n.....	16
3.1.7.5	AT Z	16

- 3.1.7.6 AT &H 16
- 3.1.7.7 AT &T 17
- 3.1.7.8 AT &V 17
- 3.1.7.9 AT &W 17
- 3.1.7.10 AT \$A 17
- 3.1.7.11 AT \$B 17
- 3.1.7.12 AT \$D 17
- 3.1.7.13 AT \$E 17
- 3.1.7.14 AT \$S 17
- 3.1.7.15 AT \$U 18
- 3.1.7.16 S Register 18
- 3.1.7.17 S0 Radio Frequency 18
- 3.1.7.18 S1 Carrier Gating Time 18
- 3.1.7.19 S2 CRC 18
- 3.1.7.20 S3 Number of Antennas 18
- 3.1.8 Function of Switches 18
 - 3.1.8.1 Function of Rotary Hex Switches 18
 - 3.1.8.2 SW1 18
 - 3.1.8.3 SW3 19
- 3.1.9 Front Panel Push Button (SW1) 19
- 3.1.10 Implemented Interface Circuits 20
 - 3.1.10.1 RS 232 (V.24) 20
 - 3.1.10.2 TTY 20
- 3.1.11 Logical Procedure of Data Transmission 21
- 3.1.12 Carrier Monitoring 21
- 3.2 Software for Communication between Memory-Programmable Control Systems via Sinec L1 Bus HG 39720_BA 22
- 3.3 Software for Communication between a Central and several Users HG 39720_CA 22
 - 3.3.1 General 22
 - 3.3.2 Software Update 22
 - 3.3.3 Transmission Rates and Interface Connections 22
 - 3.3.4 Device Addresses 23
 - 3.3.5 Schematic Procedure of Data Transmission 24
 - 3.3.6 Transmitting via Procedure 3964R 25
 - 3.3.6.1 Data Packet Output 25
 - 3.3.6.2 Acknowledgement Packet Output 26
 - 3.3.6.3 Initialization Conflicts 26
 - 3.3.7 Receiving with Procedure 3964R 26
 - 3.3.7.1 Behavior in Standby Mode (no Radio Communication) 26
 - 3.3.7.2 Behavior during Wireless Communication 26
 - 3.3.8 Block Check Character BCC 26
 - 3.3.9 Structure of Data Packets 26
 - 3.3.9.1 Data Packets 27

- 3.3.9.2 Acknowledgement Packets 27
- 3.3.9.3 Control Packets 28
- 3.3.10 Implemented Control Commands (Version 3.32 and higher):..... 28
- 3.3.11 Describing various important Control Commands 31
 - 3.3.11.1 Control Block for Reading Current Address..... 31
 - 3.3.11.2 Control Block for Reading Set Hex Address 31
 - 3.3.11.3 Control Block for Changing Current Address..... 31
 - 3.3.11.4 Control Block for Switching off Standby Function 31
 - 3.3.11.5 Control Block for Reading and Changing various Time Values . 32
 - 3.3.11.6 Control Block for Reading Error Status 32
 - 3.3.11.7 Control Block for Reading Version Number 32
 - 3.3.11.8 Control Block for Restoring Preset Values 32
 - 3.3.11.9 Control Block for Activating Test Functions 32
 - 3.3.11.10 Deactivating Standby Function 33
- 3.3.12 Radio Transmission 33
 - 3.3.12.1 Addressed Transmission 33
 - 3.3.12.2 Broadcast Transmission 34
- 3.3.13 Radio Reception 35
 - 3.3.13.1 Reception of Addressed Data Packets 35
 - 3.3.13.2 Central Transmits Broadcast Packets 35
 - 3.3.13.3 Participants Transmit Broadcast Packets 35
- 3.3.14 Block Numbering (CRC Test Method) 35
- 3.3.15 Data Packet Structure (not visible for user) 36
 - 3.3.15.1 Data Packets 36
 - 3.3.15.2 Acknowledgement Packets 36
- 3.3.16 Antenna Multiplexer (Antenna Diversity) 37
 - 3.3.16.1 Transmission 37
 - 3.3.16.2 Reception 37
 - 3.3.16.3 Participant Management 37
 - 3.3.16.4 Broadcast Data Packet..... 38
 - 3.3.16.5 Physical Connection to Antenna Multiplexer 38
- 4 Accessories 39
 - 4.1 Wall Cabinet including Power Supply (HG 7611)..... 39
 - 4.2 Interface Multiplexer HG 04330 39
- 5 Applications 40
 - 5.1 Simple Point-to-Point Data Transmission or Bus Topology with Master-Slave Operation40
 - 5.2 Measuring Point Management, Automation, Logistics, PDA.... 41
- 6 Appendix 42

A	Pin Configurations Terminal Block including Multiplexer.....	42
B	Frequency Allocations.....	42
	B.1 Frequency Range 0 (ISM Range)	42
	B.2 Frequency Range 1 (ABIN Range)	44
	B.3 Frequency Range 2 (Brazil)	44
	B.4 Frequency Range 3 (ABIN Range)	44
C	Pin Configuration of 7pin Flange Socket.....	45
	C.1 for RS 232 (V.24)	45
	C.2 for 20 mA Current Loop (TTY) or RS 422	45
D	Pin Configuration of 3pin Flange Connector	46
E	Pin Configuration of VG Blade Terminal	47
	E.1 for RS 232 Interface	47
	E.2 for TTY Interface	48
	E.3 for RS 485 Interface	49
F	Pin Configuration of 25pin Sub-D Socket.....	50
7	List of Figures	51
8	List of Tables	52
9	Index	53

1 General System Description

The radio modem HG 761 is used for asynchronous wireless data communication simplex operation. The modem is used as data communications equipment (DCE), which communicates with the data terminal equipment (DTE) via a defined interface. The modem is available in two different enclosures, a 19" slip-in cassette (DIN 41494) of 44.45 mm (1.75 inch) and 60.96 mm (2.2 inch) or flange enclosure (incl. transceiver) and there are several options regarding interfaces, power supply and software. Thus it is possible to adjust the system to the customer's hardware and/or software (DTE) requirements.

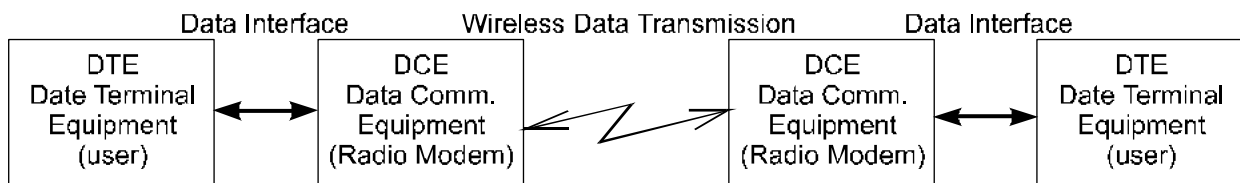

Figure 1 General System Scheme

1.1 Exclusion of Liability

Any printed information given requires written confirmation in order to be legally binding. Therefore, specifications given in this booklet are solely to be understood as product description and not as guaranteed features.

This instruction manual has been drawn up to the best of our knowledge. We guarantee that our systems leave our factory in perfect condition. Installation and operation of the equipment will be at the owner's own risk. Liability for any consequential defects and losses is excluded. We reserve the right for changes encouraging technical improvements. We also reserve the right to change the contents of this manual without having to give notice to any third party.

1.2 Copyright

This manual is protected by copyright. We therefore reserve the rights for translation, copying, lecture, taking out pictures and tables, radio transmission, microfilming, and any kind of copying and/or saving on data processing systems, even if only done partially.

Copying this manual or parts of its respectively current version is restricted within the limits of the Legal Regulations of the Copyright in the Federal Republic of Germany of Sep. 9, 1965. It is always subject to compensation. Violations are subject to penal legislation of the Copyright.

1.3 Connections

In a slip-in cassette enclosure, the modem has either a blade connector DIN 41612, type C, 32 pin or 64pin on the back or a 25 pin Sub-D socket which enables power supply and data transfer.

The flange enclosure version can be mounted anywhere without the necessity of a 19" casing (refer to Mounting Instructions). The available IP 40 enclosure offers a 25 pin Sub-D socket connector, while the IP 65 enclosure has two round plug connectors, type Binder, series 723. A three pin flanged panel plug is the power supply connector, and a seven pin flange panel socket can be used for data transfer (and power supply as option).

1.4 Front Panel Elements

LEDs and Push Buttons:

Figure 2 Front panel elements HG 761

- red LED +12V: Device ready-to-operate
- yellow LED AKTIV: Indicates Active Mode (software dependent)
- green LED RX: Device receives data
- green LED TX: Device transmits
- Push-button AKTIV: Software depending Active Mode

Connections:

- BNC/TNC-socket antenna (optional):
Connection for antenna with an antenna input impedance of 50 Ohm
- 25-pin Sub-D:
Connection for data communication cable (RS 232, RS 422, RS 485 or TTY)

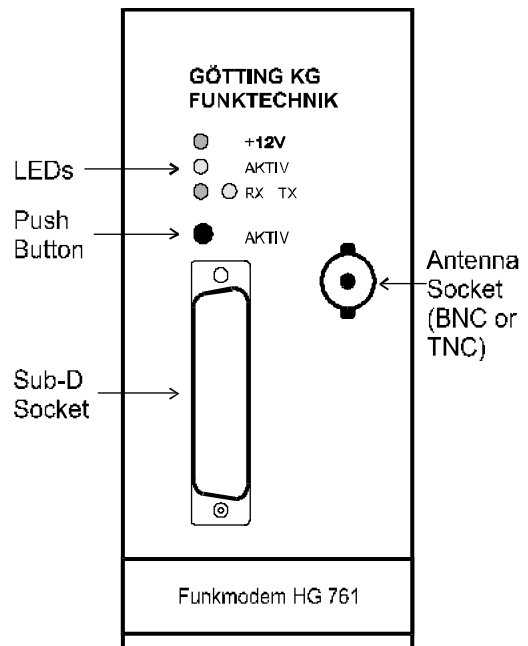

1.5 High Frequency Antenna Cable

In order to minimize signal loss, antenna cable should be as short as possible. The attenuation at a frequency of 500 MHz should be less than one decibel (take note of cable particulars!).

Suitable cabling and antennas may be purchased through us.

Standard cable:

RG 58 U (50 Ohm)	ø 4.95 mm	attenuation 0,4 dB/m (f = 480 MHz)
RG 213 U (50 Ohm)	ø 10.3 mm	attenuation 0,1 dB/m (f = 480 MHz)

2 Hardware Configurations

2.1 Power Supply

Power is supplied either through the blade connector (ST6 according to DIN41612) on the back, the 25 pin Sub-D socket on the front or the round plug connector on the back depending on the ordered version. The modem is equipped with an integrated potentially separated DC/DC Converter. There are two different versions available: input voltage range 9 to 36 Volts or 18 to 72 Volts.

Input Voltage Range	Power Assumption (Transceiver 500 mW)	Current Assumption During Transmission	potentially separated	Ordering information
+9 V to +36 V	5,3 Watt	600 to 150 mA	X	24 V
+18 V to +72 V	5,3 Watt	300 to 75 mA	X	48 V

Table 1 Available power supply versions

2.2 Interfaces

Depending on the customer specifications, it is possible to realize three different ways of transmitting data from the DCE (modem) to the DTE, which eliminate each other. Thus it is essential that the corresponding interface specifications are stated in the order.

2.2.1 RS 232 Interface

RS 232 (V.24; integrated in the modem) is a standardized voltage interface which operates bit serial and asynchronous with one start bit and one or two stop bits. A logical one indicates a voltage value between -3 V and -15 V, a logical zero indicates a voltage value between +3 V and +15 V. The range between -3 V and +3 V is undefined. Data transmission rate of the interface is max. 19200 baud according to DIN; it depends on the software used. This interface is not potential free. Following a description of the RS 232 interface signals:

Function within the Modem	standardized Name
Read data from DTE (input)	TXD
Output data to DTE (output)	RXD
Switch on transmitter (input)	RTS
Ready-to-transmit (output)	CTS

Table 2 RS 232 signals implemented within the modem (part 1 of 2)

Function within the Modem	standardized Name
DTE ready-to-operate (input)	DSR
Signal ground	SG
DCE ready-to-operate (output)	DTR

Table 2 RS 232 signals implemented within the modem (part 2 of 2)

2.2.2 TTY Interface

TTY interface is a serial 20 mA current interface. A logical 1 is realized by a current of 20 mA, a zero by no current at all. The advantage of this interface is that it enables potential free structure on the one hand and on the other hand increases transmission distances (e. g. 1 km) through optimized interference immunity.

It is possible to set various operating modes on the TTY interface plug-in module HG 9262 (module M2) through jumpers. Three different modes are available:

- ♦ passive
(potential free)
- ♦ active user – optocoupler switches to ground
(potential free only in combination with potential free DC/DC converter)
- ♦ active user – optocoupler switches to +12 V
(potential free only in combination with potential free DC/DC converter)

There are four TTY line pairs:

Function within the Modem	standardized Name
Transmit data (output)	RD
Receive data (input)	TD
Transmitter on (input)	RTS
Data carrier recognized (output)	DCD

Table 3 TTY line pairs implemented in the modem

Following a list of TTY interface operating modes of the radio modem (DCE):

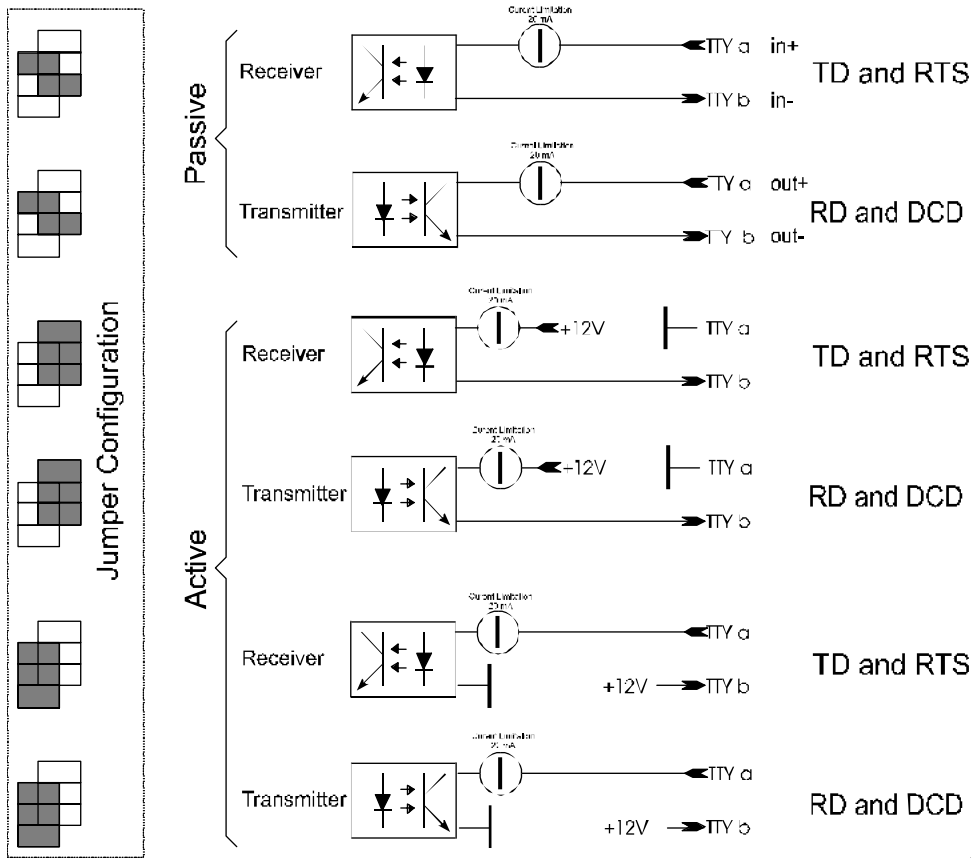

Figure 3 Operating modes of the modem's TTY interface

Operating mode is set by jumpers on the TTY interface board HG 9262 (also refer to Figure 4).

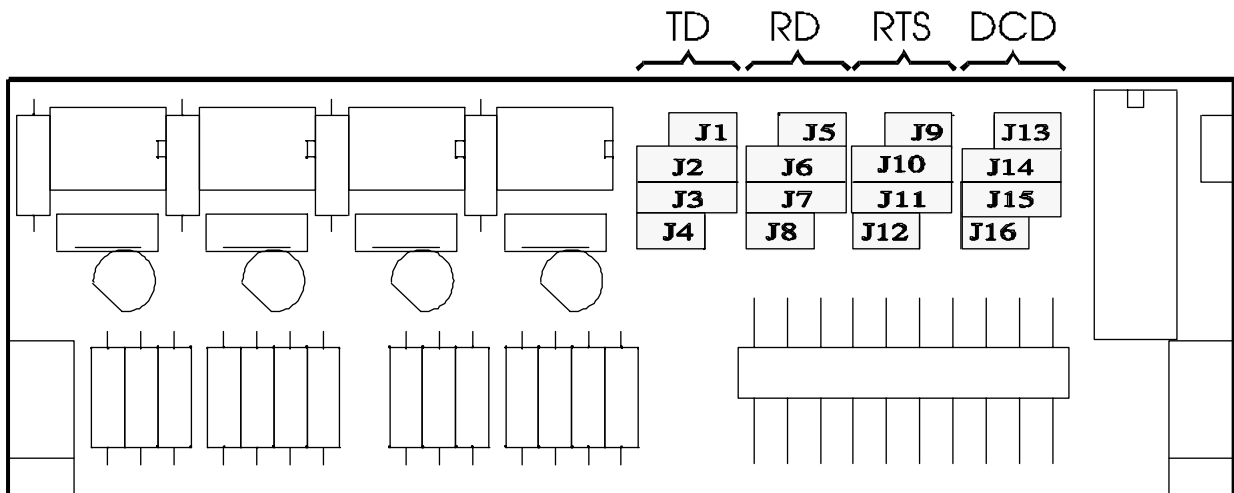

Figure 4 Setting operating modes via jumpers on TTY interface board HG 9262

2.2.3 RS 485 Interface

RS 485 interface (integrated in the modem) is a symmetric interface, which enables significantly higher transmission rates and cable lengths. An interface cable terminated with the conductor resistance allows up to a cable length of 1 km a transmission rate of 100 kbit/s. However, this data is only correct for the data transmission interface and not for the RF transmission.

The RS 485 interface only consists of a symmetric wire pair, i. e. modem control has to be completely realized through a software protocol that is to be defined. It is possible to implement a bus topology in order to enable several modems to be connected to a DTE. Differentiation between the single devices is possible through different addresses adjustable on the modem.

It is possible to solder in a terminal resistance that is corresponding to the conductor resistance at each end of the bus (refer to Figure 5 „Layout of the board of the radio modem“ on page 12: R36 on LP1 and LP2, IC10 is the interface IC).

2.2.4 RS 422 Interface

RS 422 interface corresponds to the RS 485 interface with regards to their levels. However in contrast to the RS 485 it has separated wire pairs for transmitting and receiving and thus enables duplex operation (for the interface).

2.2.5 Analog Interface

Special analog input and output modules have been designed for telemetric applications. They enable transfer of analog voltages (0 to 5 Volt) or currents (0 to 20 mA) as digital values and output of both as either analog or digital values. The resolution is either 10 or 12 bit.

2.3 Transceiver

The data edited by the microprocessor and the corresponding implemented program are transmitted wireless by the transceiver integrated in the modem over a large distance. Depending on the national regulations in the different countries, several frequencies are available for wireless communication.

Usually frequencies 433,15 MHz to 434,75 MHz at 25 kHz channel separation are available in the ISM band. In addition frequencies in the range of 456 MHz and 466 MHz (so-called ABIN frequencies in Germany) are possible. For further country specific frequency ranges, please refer to chapter B „Frequency Allocations“ on page 42).

The transceiver has been tested and approved by the German BZT. Type approvals for other countries have as well been acquired. Detailed information on the currently available type approvals on request. Modulation method is GMSK (9,6 kbit/s):

- ♦ GMSK (Gaussian Minimum Shift Keying)
Special phase shift keying
- ♦ This modulation method switches the phase of the carrier wave according to the data signal and undergoes a special filtering process.

2.4 Board

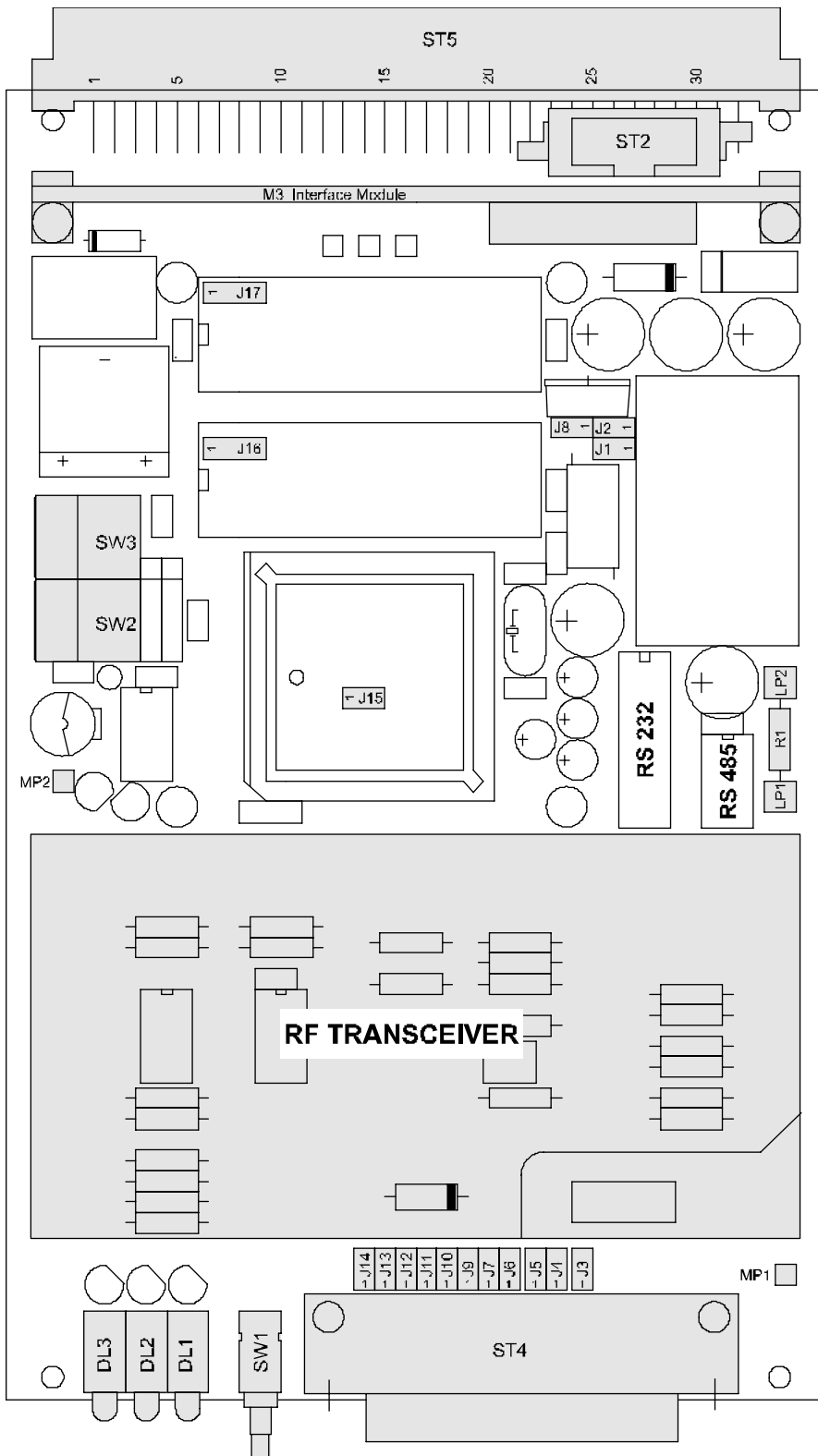

Figure 5 Layout of the board of the radio modem

2.5 Software Revisions

Following is a list of currently available software revisions including a short description of their respectively special functions. This will help you to select the software version you need and order it accordingly. An extensive description of all software versions is included in the next chapter. In addition even more software variants are available in combination with the Wireless Communication Transceiver HG 754 (on-frequency). Please refer to this system description up to revision G.

Software Variant	Revision	Function
39720AA	3.01	transparent data transmission, various interface parameters adjustable
39720BA	3.00	Sinec L1 protocol
39720CA	3.35	3964R Procedure (limited RK 512)

Table 4 List of software revisions

2.6 Available Variants of System HG 761

Power Supply	Enclosure	VG Blade Connector	RF Frequency	Interface	Software
depending on software version				Only in combination with appropriate software	
24 V* 48 V	60.96 mm flange IP40* flange IP65	C32 C64 *) none	433,10 MHz ... 434,475 MHz *) ... 434,75 MHz 456,21 MHz 456,25 MHz 456,33 MHz 466,21 MHz 466,25 MHz 466,33 MHz others on request	RS 232 *) RS 422 RS 485 TTY analog	HG 39720_AA HG 39720_CA HG 39720_BA
*) Standard option					

Table 5 List of system HG 761 variants

When ordering, please list variants completely!

E. g.: HG 761A / 24V / 12TE / C64 / 434,475 MHz / RS232 / HG39720_CA

3 Software Versions

On request, we are prepared to develop customized hardware and software variants of this system. So far the following software variants are available:

Software	HG 39720_AA	HG 39720_BA	HG 39720_CA
Application (described on page)	Software for transparent data transmission including carrier control (page 14)	Sinec L1-Bus (page 22)	3964 R-Procedure (page 22)
accompanying Hardware	<ul style="list-style-type: none"> ♦ RS 232, RS 422, RS 485 or TTY interface ♦ 1,2 kbit/s to 19,2 kbit/s adjustable ♦ 9,6 kbit/s radio transmission 	<ul style="list-style-type: none"> ♦ RS 232, RS 422 or TTY interface ♦ 9,6 kbit/s interface ♦ 9,6 kbit/s radio transmission 	<ul style="list-style-type: none"> ♦ 1 central ♦ 127 mobile participants ♦ RS 232, RS 422, RS 485 or TTY interface ♦ 9,6 kbit/s interface ♦ 9,6 kbit/s radio transmission

Table 6 Software Variants

3.1 Software for transparent Data Transmission including Carrier Control HG 39720_AA

3.1.1 Introduction

The Wireless Communication Modem HG 761 including software HG 39720 AA is used for transparent data transmission. It is possible to set baud rate and parameters of the serial interface using two hex-rotary switches (also refer to chapter 3.1.8.1 „Function of Rotary Hex Switches“ on page 18). Wireless data transmission is always running at 9600 baud.

3.1.2 Software Description

Interface RS 232, RS 422, RS 485 or TTY

Transmission rate of the serial interface is 1200 to 19200 baud half duplex. A hex-rotary switch enables setting different transmission parameters. Whenever CRC is active, transmission errors are detected and incorrect data is not being output. Without CRC transmission errors are neither detected nor corrected. This modem is a Data Communication Equipment (DCE), whose interface to the Data Terminal Equipment (DEE) is defined by DIN 66020.

Communication via this modem can be realized by control lines. The modem will automatically switch into transmitting mode as soon as signs are in the buffer. These control lines may be used, but they do not have to be used.

Once a sign was received by the serial interface or following setting of the RTS line the carrier is switched on. However, this is only the case if at the same time no foreign carrier is being detected. In that case the system would wait until the foreign carrier is

abolished, while buffering the serial interface data. In case transmission is enabled, data is being transmitted until there is none left in the buffer and no additional data was received by the serial interface for the time t_p .

t_p [ms]	Baud Rate [Bd]
3	19200
5	9600
10	4800
20	2400
40	1200

Table 7 Duration of waiting period t_p at different baud rates

Once all data is transmitted and RTS line reset, the transmitter is turned off and the system switches to receiving mode.

3.1.3 Data Buffer

In case of transmission and reception, data buffer of 1024 byte each are available. While transmitting and receiving, data is at the same time wrote into and read out of this buffer. Since the transmission rates of serial interface and radio transmission differ, the actually available buffer is larger. A possible buffer overflow cannot be prevented and results in loss of data. If this is the case, it is necessary to make the data blocks smaller or implement short waiting periods in the data stream (have to shorter than t_p (also refer to Table 7).

3.1.4 CRC (Cyclic Redundancy Check)

3.1.4.1 Operation without CRC

When operating without CRC, following receipt, all data is output immediately. In this case no further error check is generated.

3.1.4.2 Operation with CRC

When operating with CRC, a 16 Bit CRC checksum over the transmitted data is generated and added to the transmitted data block.

On the receiving side, the data is recorded within the radio modem until the CRC checksum has been received. In case this check is successful the data is output, otherwise all data is chopped.

3.1.5 Hardware-Handshake RTS/CTS

The RTS line enables direct switch on of the transmitter (even if no data is being transmitted), if at the same time no foreign carrier is being detected. Switch-on of the transmitter is always acknowledged by setting the CTS line. Once RTS line has been set, CTS line must not be evaluated immediately, but a waiting period of approx. 100 μ s has to be obeyed.

3.1.6 Command Mode

Command mode is used for execution of service functions as well as adjustment of parameters. In order to switch from online operation to command mode, the following sequence has to be carried out:

Sequence min. 1 second break, `[+][+][+]`, min. 1 second break

Time between entering the plus characters must be less than 1 second. The three entered plus characters are transmitted before command mode is confirmed by output of `OK`.

In command mode all entered signs are returned (Echo). If for more than 60 seconds no signs are entered, the system automatically switches back to online operation.

Any commands entered in command mode have to be preceded by `[AT]` and it is possible to enter more than one command per line. The commands are executed following pressing of `Enter` (CR).

Example `AT &H (CR)`
 `AT &V $A $B (CR)`

3.1.7 AT Commands

Some AT commands expect numeric transmission values or values are returned. These values are always decimal ASCII coded.

3.1.7.1 AT I

Output of software versions:

`I0` Software version of main program
`I1` Software version of radio modem controller

3.1.7.2 AT O

Exit command mode and return to online operation.

3.1.7.3 AT Sr?

Output of register value from register `x`.

Example `AT S1? (CR)`

3.1.7.4 AT Sr=n

Sets value from register `x` to new value `n`.

Example `AT S1=25 (CR)`

3.1.7.5 AT Z

S register is reloaded with the new values saved in the EEPROM. This procedure is also followed when switching on the device.

3.1.7.6 AT &H

Output of list of possible commands (online help).

3.1.7.7 AT &T

Test functions for radio operation:

- &T0** Transmitter is switched on non-modulated.
- &T1** Transmitter is switched on and modulated by a sync sequence.
- &T2** Transmitter is switched on and modulated by a random sequence.

By entering any sign or pressing the front push-button, it is possible to exit this test function.

3.1.7.8 AT &V

Output of all current values of all S registers.

3.1.7.9 AT &W

Currently selected values of S register are permanently saved.

3.1.7.10 AT \$A

Output of RSSI values:

- \$A0** Analog RSSI value
- \$A1** RSSI value from radio transceiver

3.1.7.11 AT \$B

Output of RSSI reception threshold set in the radio transceiver.

3.1.7.12 AT \$D

Default values set by manufacturer are loaded into the S register (in order to save these values permanently it is necessary to carry out the **AT &w** command).

3.1.7.13 AT \$E

Output of error status. Each system error is coded bit-by-bit:

- Bit 0** Watchdog reset
- Bit 3** EEPROM error
- Bit 4** RAM error
- Bit 5** Error during communication with radio transceiver

Once status has been read, the value is deleted.

3.1.7.14 AT \$\$

Function for setting the RSSI reception threshold within the radio transceiver. Once the pass word is entered, the current RSSI value can be imported.

ATTENTION! Import of a new RSSI value cannot be cancelled!



3.1.7.15 AT\$U

Function for updating the firmware. Once a RAM test has been executed, the new firmware as ASCII upload in Intel-Hex format is expected. 60 seconds until start of the upload are available. Following the update, a message about its result is output and the radio modem restarted.

3.1.7.16 S Register

S registers comprise system parameters, which may be changed by the operator. Changing these values is always temporary. In order to permanently save changed values, AT &W has to be executed.

3.1.7.17 S0 Radio Frequency

The decimal number has to be converted to the corresponding frequency using a table.

3.1.7.18 S1 Carrier Gating Time

Values of 6 to 50 milliseconds are allowed for the carrier gating time.

3.1.7.19 S2 CRC

The following values are allowed:

- 0 CRC off
- 1 CRC on

3.1.7.20 S3 Number of Antennas

Number of connected antennas if hardware for antenna diversity is included. This value must always correspond to the actual number of antennas. Values 1 through 4 are possible.

3.1.8 Function of Switches

3.1.8.1 Function of Rotary Hex Switches

Rotary hex switches SW2 and SW3 enable setting several default values for the device, however their settings are only evaluated when the device is switched on.

3.1.8.2 SW1

Bit 1	Bit 0	Function
0	0	8, N, 1 or 7, E, 1 or 7, O, 1
0	1	8, E, 1
1	0	8, O, 1
1	1	8, N, 2 or 7, E, 2 or 7, O, 2

Table 8 Function of bits 0 and 1 of rotary hex switch SW2

Bit 3	Bit 2	Function
0	0	STBY switches to passive at Low; wireless communication switches active
0	1	STBY switches to passive at High; wireless communication switches active
1	0	STBY switches to active at Low; wireless communication does not switch
1	1	STBY switches to active at High; wireless communication does not switch

Table 9 Functions of bits 2 and 3 of rotary hex switch SW2

3.1.8.3 SW3

Bit 2	Bit 1	Bit 0	Function
0	0	0	19200 baud
0	0	1	9600 baud
0	1	0	4800 baud
0	1	1	2400 baud
1	0	0	1200 baud
1	0	1	4800 baud
1	1	0	4800 baud
1	1	1	4800 baud

Table 10 Functions of bits 0, 1 and 2 of rotary hex switch SW3

Bit 3 no function

3.1.9 Front Panel Push Button (SW1)

The front panel push button (only if integrated) enables switching between active and passive mode. However, this is only possible, if the position is not preset by input STBY.

3.1.10 Implemented Interface Circuits

3.1.10.1 RS 232 (V.24)

Description according to DIN	Function	Direction of Transmission
TD (D1)	Transmission Data	DCE <- DTE
RD (D2)	Received Data	DCE -> DTE
RTS (S2)	Switch on transmission equipment	DCE <- DTE
DSR (M1)	Ready Status	DCE -> DTE
CTS (M2)	Ready-to-transmit-state	DCE -> DTE
DCD (M5)	Level of reception signal recognized	DCE -> DTE

Table 11 Interface circuits for RS 232

A control line is active, if its level is > +3 Volt.

A control line is inactive, if its level is < -3 Volt.

3.1.10.2 TTY

Description according to DIN	Function	Direction of Transmission
TD (D1)	Transmission data	DCE <- DTE
RD (D2)	Received data	DCE -> DTE
RTS (S2)	Switch on transmission equipment	DCE <- DTE
DCD (M5)	Level of reception signal recognized	DCE -> DTE

Table 12 Interface circuits for TTY

A line is inactive, if current is < 5 mA.

A line is active, if current is > 15 mA.

3.1.11 Logical Procedure of Data Transmission

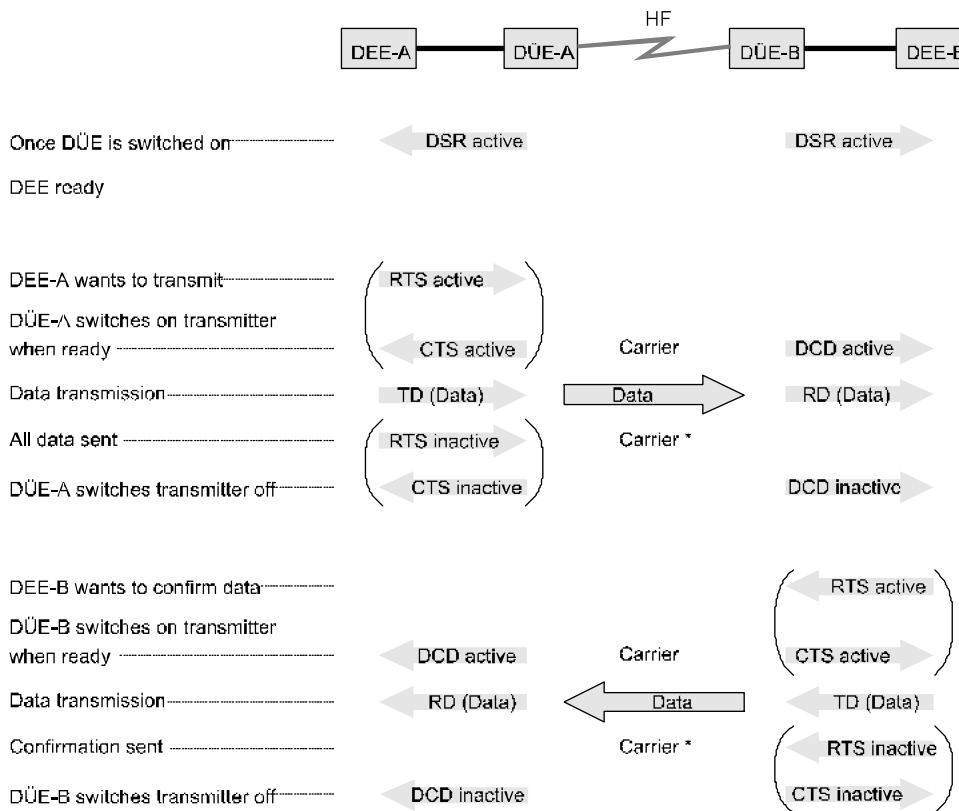

Figure 6 Description of logical procedure of data transmission

- *) The carrier is switched off, in case RTS is being inactive for more than 5 msec. Within this period of time, CTS reacts immediately to RTS because the connection is still existing. In case the control lines are not used, the transmitter is switched off automatically whenever the buffer remains empty for the period of two signs.

3.1.12 Carrier Monitoring

Carrier monitoring enables generation of any switching procedures by an HF carrier of a minimum of 5 msec. This state is indicated by the yellow LED. Its complementary switching procedure is activated by a pulse of a duration of a minimum of 25 msec at pin 21a (blade-connector strip on the back).

During testing it is possible to activate these switching functions by pressing the push-button, even if carrier monitoring is switched off (yellow LED off).

The relay (1x time, 1A, 150V~/125V~) is connected to pins 15a, 17a, 19a of the blade-connector strip.

3.2 Software for Communication between Memory-Programmable Control Systems via Sinec L1 Bus HG 39720_BA

This software was developed for the communication between several PLCs, that have access to a Sinec L1 Bus. The implemented protocols cover Master-Slave Operation and cross traffic between Slaves and temporary Master.

3.3 Software for Communication between a Central and several Users HG 39720_CA

3.3.1 General

Interfaces RS 232, RS 422, RS 485 or TTY

Data exchange between Data Communication Equipment (DCE) HG 761 and the corresponding Data Terminal Equipment (DTE) is carried out and controlled by 3964R procedure from Siemens, which is designed for linking two computers. Thus for procedure 3964R the modems HG 761 have to appear to be a transparent connection, on the other hand, various commands are necessary for the control of the modem (e. g. altering frequency) that are not to be transferred to the corresponding twin-device. Procedure 3964R describes full duplex operation, i. e. in this case it has been modified for half duplex data communication.

NOTE! Software versions 1.40 and higher are not HF compatible to former versions.



3.3.2 Software Update

Götting's PC program 39720A11.EXE enables automatic loading of the new software in Intel-Hex format into the radio modem's flash EPROM, without mechanically opening the enclosure of the modem. Connect an IBM compatible PC to the radio modem using the serial interface. Then start program 39720A11.EXE on the PC.

NOTE! Whenever this program is started without any additional parameters, extensive operating instructions are available.



If the PC is e. g. connected to the radio modem via serial port COM2, a complete program start would be like this:

```
39720A11 2 39700CA3.35H
```

Then the new software version in Intel-Hex format is automatically loaded into the EPROM of the radio modem. Status messages on the PC screen keep the operator informed of the current state of the programming procedure.

3.3.3 Transmission Rates and Interface Connections

Transmission rate between computer and radio modem is 9600 baud, 8 data bits, one stopbit and even parity. With this procedure handshake lines are not necessary however can be defined on request (the hardware of the modem board HG 39720 includes

input line RTS and output lines CTS and DCD). Radio Modem HG 761 is equipped with one of the following interfaces: RS 232, TTY-20mA or RS422/RS485. Wireless data transmission is at a rate of 9,6 kbit/sec.

3.3.4 Device Addresses

A HEX switch on the main board of the modem enables setting a fixed address for each device. The following configurations are possible:

Set device address	Able to transmit packets whose addresses are	Able to transmit packets whose addresses are
0 (fixed station)	any	
1... 127 (vehicle)	device's own address or 0	

Table 13 Settings of device addresses

Changing the current address may be effected via Control block A2_{hex} (also refer to page 28).

3.3.5 Schematic Procedure of Data Transmission

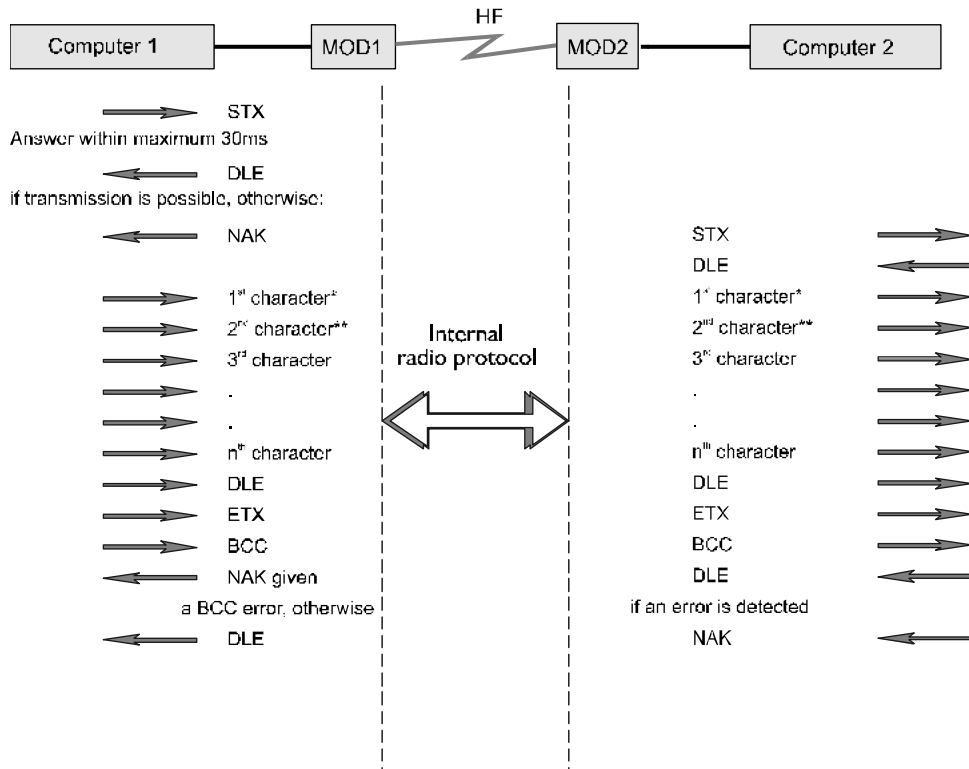

If an error causes negative acknowledgement

Otherwise with a positive acknowledgement

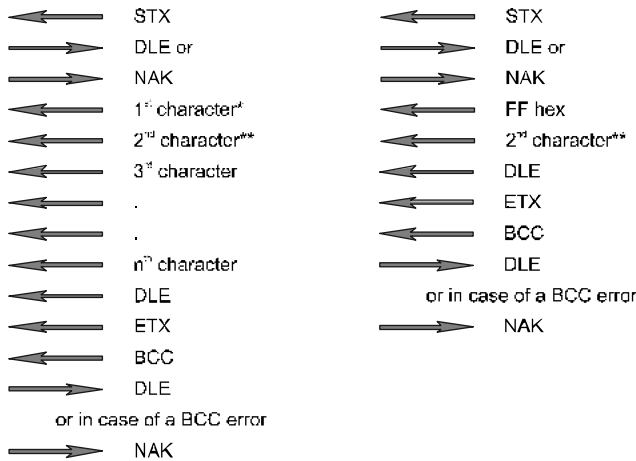

Figure 7 Schematics description of data transmission

(*) If the data block from MOD2 is acknowledged negatively or not at all within the internal radio protocol, it is reflected to the system computer. The block's first character includes an error status, its second character corresponds to the address, the third character is followed by a repetition of the block to be transmitted (thus it does not have to be buffered within the system computer.)

In order to have transmission and acknowledgement blocks equally structured, an additional character is added to the transmission block.

On the vehicle side the first character output is identification 00_{hex} in order to identify this block clearly as data block and to have it in the same structure as the acknowledgement block from 3.3.15.2 „Acknowledgement Packets“ on page 36.

- (**) A data block's second character has a special meaning: Values $< 80_{\text{hex}}$ indicate that it is an address; values $> 7F_{\text{hex}}$ indicate a device control instruction: e.g. 80_{hex} indicates that the following character will include frequency information.

Data packets that start with a character $> 7F_{\text{hex}}$, are not transmitted to the twin-station. On the vehicle side the second character indicates the address set on the modem.

3.3.6 Transmitting via Procedure 3964R

3.3.6.1 Data Packet Output

For connection set-up, procedure 3964R transmits control character *STX*. If the twin device answers before the programmable acknowledgement delay period has passed (1 ms to 2000 ms) by sending character *DLE*, procedure 3964R will switch to transmission mode. If the twin device answers with a different character or the character reply time (adjustable from 1 ms to 2000 ms) passes without any reaction, connection set-up failed. The number of output attempt is programmable between 1 and 255. In case connection set-up fails, the failure is reported to the program and character *NAK* is transmitted to the twin-device.

In case connection set-up is successful the useful data is transmitted to the twin device. If the date of character *DLE* is to be output additionally, the character is to be transmitted twice.

Following the transmission of useful data procedure 3964R adds characters *DLE*, *ETX* and block check character *BCC* and waits for the acknowledgement signal. If the twin device then answers with a character that is not *DLE* or acknowledgement delay time passes without any reaction, output of the data block is repeated as described above. If the data transmission fails, the program is notified of this failure and character *NAK* transmitted to the twin device.

If the twin device transmits character *NAK* during a data transmission, procedure 3964R terminates the data transmission and repeats it as described above. If any other character is transmitted, the procedure waits until character reply has passed and then transmits *NAK*. Following this, output is repeated.

3.3.6.2 Acknowledgement Packet Output

Output of acknowledgement packet is the same as output of data packets as described in chapter 3.3.6.1 „Data Packet Output“ on page 25, except for the fact, that the number of output retries is indefinite. This ensures that the acknowledgement packet is actually received by the twin device.

3.3.6.3 Initialization Conflicts

If a device answers a `STX` character from its twin device equally with a `STX` character, an initialization conflict is generated. The device with the lower priority delays its transmission and answers with the character `DLE`. The device with the higher priority transmits its data in the above described manner. Once the connection has successfully been completed the device with the lower priority will finish its transmission. The priority of the Radio Modem HG 761 is set to `high priority`.

3.3.7 Receiving with Procedure 3964R

3.3.7.1 Behavior in Standby Mode (no Radio Communication)

If the procedure receives a character different from `STX`, it waits until the character reply time has passed and then transmits character `NAK`.

In case procedure 3964R receives the character `STX`, it answers with `DLE`. Data following this character will be transferred to the program as useful data. If two `DLE` characters are received in sequence, only one of them is forwarded.

Following each received character procedure 3964R waits for the next character for the period of the character reply time. In case the character reply time passes without a signal being received, character `NAK` is transmitted to the twin device and the already received data rejected.

3.3.7.2 Behavior during Wireless Communication

During transmission and reception procedures, procedure 3964R is not able to accept a data block. If procedure 3964R receives character `STX`, it answers with character `NAK`. Any character different from `STX` does not generate any action.

3.3.8 Block Check Character BCC

At the end of each data block, block check character `BCC` is transmitted to safeguard its information. `BCC` is the horizontal even parity of the information bits of all data bytes included in a block. It is formed by the useful data bytes and ends after characters `DLE` and `ETX` during termination of the connection.

3.3.9 Structure of Data Packets

A packet's data bytes consist of a gap character, user address and a maximum of 1024 byte useful data.

3.3.9.1 Data Packets

Data packets transmitted and received by procedure 3964R are constructed as follows

Gap Character – undefined during reception, always zero during transmission

Address –user address (0 to 7F_{hex})

Data – useful data (0 to FF_{hex})

Since it is essential that an address is transferred each time, there may be problems with computer interconnection RK 512 (Siemens). Reasons are that in this case a fixed packet head is generated which cannot be changed by the user.

3.3.9.2 Acknowledgement Packets

Acknowledgement packets are generated by the radio modem and transferred to the twin device. There are both positive and negative acknowledgement packets.

A positive acknowledgement is output in case wireless data transmission has been successful. The procedure's acknowledgement consists of two data bytes, no useful data:

FF_{hex} - Identification of positive acknowledgement

Address - User address

In case the wireless data transmission was interrupted or a data block was not transferred to the twin device, procedure 3964R transmits the transferred data block together with a status message (gap character) as negative acknowledgement:

Acknowledgement Packets	
01	No acknowledgement received
02	Timed out after first STX
03	Timed out after second STX (initialization conflict)
04	A character other than DLE was received after the first and/or second STX
05	NAK received during data output
06	Trouble character (other than NAK) received during data output
07	Character other than DLE received after BCC
08	Timed out waiting for BCC
80 _{hex}	Standby overt

Table 14 Acknowledgement packets

3.3.9.3 Control Packets

If procedure 3964R receives data packets with addresses higher 7F_{hex}, this address is interpreted as control command. The data block must have the following format:

- gap character – any value
- control command – 80_{hex} to FF_{hex}
- data – value to be transmitted

Transfer of a numerical value may be done in either a decimal or hexadecimal format. This value has to be ASCII coded. Hexadecimal values are identified by leading 'X' (58_{hex}) or 'x' (78_{hex}). In both cases leading zeros are permissible.

- e.g.: value = 5: <35_{hex}>;
 <30_{hex}, 30_{hex}, 30_{hex}, 35_{hex}>;
 <58_{hex}, 35_{hex}>;
 <58_{hex}, 30_{hex}, 35_{hex}>
- e.g.: value = 30: <33_{hex}, 30_{hex}>;
 <30_{hex}, 33_{hex}, 30_{hex}>;
 <78_{hex}, 31_{hex}, 45_{hex}>;
 <58_{hex}, 30_{hex}, 30_{hex}, 31_{hex}, 45_{hex}>

Transferring texts is to be done left flush and additional following characters are allowed.

- e.g: Value = OFF: <4F_{hex}, 46_{hex}, 46_{hex}>;
 <4F_{hex}, 46_{hex}, 46_{hex}, 41_{hex}, 42_{hex}, 43_{hex}>

For some control packets the modem returns numerical values. They are decimal ASCII coded.

- e.g.: Value = 173: <31_{hex}, 37_{hex}, 33_{hex}>

3.3.10 Implemented Control Commands (Version 3.32 and higher):

Describing control characters, values in parenthesis have the following meaning:

Adr.	Functions	per.	Default	Value	new for 3.32 and higher
81	Changing number of transmission retries wireless communication	X	6	1 - 11	
82	Changing number of transmission retries 3946R	X	5	1 - 255	
83	Changing character reply time 3946R	X	30	5 - 30	

Table 15 Implemented Control Commands (Version 3.32 and higher) (part 1 of 3)

Adr.	Functions	per.	Default	Value	new for 3.32 and higher
84	Changing character reply time wireless communication	X	5	1 - 30	
85	Changing carrier rise time	X	10	3 - 30	
86	Changing acknowledgement delay time 3946R	X	30	5 - 2000	
87	Changing number of output retries 3946R acknowledgement	X	255	0 - 254, 255	
8a	Permanently setting frequency	X	0	0 - 255	X
8b	Temporarily setting frequency			0 - 255	X
8c	Setting RSSI threshold according to measured RSSI value	X		RSSI	X
8d	Setting repetition time for indicating telegram	X	0	0 - 9999	X
90	Switching relays			ON, on, OFF, off	
a0	Reading current address				
a1	Reading Hex switch				
a2	Changing current address	X	Switch	0 - 127	
a3	Changing address for lower boundary of range	X	1	1 - 127	
a4	Changing address for upper boundary of range	X	127	1 - 127	
a5	Reading current lower address				
a6	Reading current upper address				
a7	Clearing address			1 - 127	
a8	Blocking address			1 - 127	
a9	Clearing or blocking all addresses			ON, on, OFF, off	
aa	Reading binary clearing table				
b0	Reading field intensity in AD parts			0 - 127	
b1	Changing number of antennas	X	1	1 - 4	
b2	Reading field intensity of a certain antenna in AD parts			0 - 3	

Table 15 Implemented Control Commands (Version 3.32 and higher) (part 2 of 3)

Adr.	Functions	per.	Default	Value	new for 3.32 and higher
b3	Reading field intensity in dBm			0 - 127	
b4	Reading field intensity of a certain antenna in dBm			0 - 3	
b5	Reading current number of antennas				
b6	Reading current transmission retries wireless communication				
b7	Reading current transmission retries 3964				
b8	Reading current character reply time 3964				
b9	Reading current character reply time wireless communication				
ba	Reading current carrier rise time				
bb	Reading current acknowledgement delay time 3964				
bc	Reading current acknowledgement output retries 3964				
bd	Reading current frequency				X
be	Reading value for RSSI threshold				X
bf	Reading current repetition time for indicating telegrams				X
c0	Reading error status				
c1	Reading version number of modem HG 761				
c2	Resetting parameter	X		DEF, def	
c3	Reading system status				
c4	(De)activate or read switch-on message	X	OFF	ON,on, OFF, off	
c5	Multiplexer mode		OFF	ON,on, OFF off	
c6	Reading version number of transceiver HG 75430				X
d0	Firmware download			!Program!	
e0	Test functions			TC1, TC2, TC3	

Table 15 Implemented Control Commands (Version 3.32 and higher) (part 3 of 3)

The program checks any transferred values and ignores them in case of an error. Any adjustable parameters are automatically permanently saved in an EEPROM if overwritten.

- Faulty communication with the internal transceiver is indicated by error code 5 (LED blinks 5 times, bit 5 (xx1x xxxx) is set in error status).
- The most significant bit of the hex switch defines the SIO baud rate:
0 = 9600 baud, 1 = 4800 baud
- Users are able to transmit an indicating telegram in adjustable intervals. This telegram is output at the central and is constructed as follows: Dummy (0x00), user address. This telegram enables automatic inscription from another fixed station (autom. Handover) in multiplexer mode (several fixed stations) even in case the system is not in normal data communication operation.

3.3.11 Describing various important Control Commands

3.3.11.1 Control Block for Reading Current Address

The current address is the address at which it is currently possible to address the modem wireless. The modem answers to the control block with address $A0_{\text{hex}}$ with its current address decimal ASCII coded.

Address of the output block is again address $A0_{\text{hex}}$. Versions 1.4B or higher provide a non volatile memory (EEPROM) in which the current address is stored. Thus the address is stored when switching off the device and it is again available when the device is switched on again.

3.3.11.2 Control Block for Reading Set Hex Address

The set address is the one that was preset on the rotating hex switch. It is only read when the modem is switched on.

A control block using address $A1_{\text{hex}}$ causes the modem to return its set hex address in ASCII coded decimal.

Output and input address are identical.

3.3.11.3 Control Block for Changing Current Address

A control block using address $A2_{\text{hex}}$ enables setting a new current address. An address zero will only be accepted if the modem is fitted with RAM.

The modem is then re-initialized. All alterable parameters will be preserved. Standby function remains in its current state.

3.3.11.4 Control Block for Switching off Standby Function

A control block of address 90_{hex} is able to either switch off standby function by sending an ASCII coded block 'ON' or 'on' or switch it on by sending 'OFF' or 'off' in the same way.

3.3.11.5 Control Block for Reading and Changing various Time Values

83_{hex}, 86_{hex}, b8_{hex} and bb_{hex} enable reading and setting character reply time and acknowledgement delay time. This is important for communication with some PLC (programmable logic control) or self-made 3964R drivers, since in these cases time values may be larger than the preset values and thus unnecessary repetitions and delays may occur.

3.3.11.6 Control Block for Reading Error Status

The modem answers a control block of address C0_{hex} with a three digit decimal ASCII coded number in the range of 0 to 255. Each set bit of its binary presentation indicates a certain error.

If error status zero is output, no error was detected.

Reading procedure sets status to zero.

Error Description	Status Bit	Action
RAM not included or defective at current address zero	---	Active LED permanently blinking
Watchdog Timeout	Bit 0	Reset
EEPROM defective	Bit 3	Active LED blinks three times

Table 16 Control block values while reading error status

3.3.11.7 Control Block for Reading Version Number

A control block with address C1_{hex} is answered by the modem with an ASCII coded string, which indicates the software version number. Address C6_{hex} reads out the software version integrated in the transceiver.

3.3.11.8 Control Block for Restoring Preset Values

Control block C2_{hex} enables restoring the factory set values for all parameters except the current address.

3.3.11.9 Control Block for Activating Test Functions

Control block E0_{hex} enables activating test functions. The following data divisions are assigned a function:

Data Division	Action
TC1	Permanent carrier is transmitted
TC2	Permanent sync sequence is transmitted
TC3	Random signal is transmitted

Table 17 Control block values for activating test functions

By pressing the push-button on the front panel or by switching the device off and then on again, these test functions may be reset. If an error occurs during RAM test, it is indicated by a permanently blinking RX LED (in former versions generated by a relay).

3.3.11.10 Deactivating Standby Function

This function is executed either by an external 'Wake-Up' push-button, which is located on the modem or by reception of a valid data block, which is addressed to the modem. Thus it is possible to wake up certain users by addressing them directly. Address zero wakes up all of them.

The first data block received in standby mode is acknowledged to the FuKo (mobile switching station) as faulty transmission to the participant's computer (status = 80_{hex}), however it is not transferred to the receiving computer.

Logic level for standby switching input, pin 21a of the 64pin blade-connector strip:

- ♦ $U_l = 0$ to 2.0 V
- ♦ $U_h = 3.0$ to 100 V

This input is used for activating a participant (out of standby mode).

Active high -> wake up.

The software addresses a relay (single-contact, make-break-contact), whose contacts are connected to the 64pin blade-connector strip and the Sub-D socket.

In standby mode center and break contact are connected, in operation mode center and make contact. Control block 90_{hex} enables activating and deactivating this function by the participant's computer.

3.3.12 Radio Transmission

3.3.12.1 Addressed Transmission

Useful data received by procedure 3964R is transferred permanently to a higher program and stored in a buffer.

Following the recognition of a valid address it is checked whether the RF channel is currently used for radio transmission. If this is not the case, the carrier is switched on and following the set carrier rise time (6 to 30 msec) radio transmission is activated. In case procedure 3964R detects an error during a running transmission, this error is reported to the program and radio transmission is interrupted. In order to avoid that the recipient processes the already received data, the data packet's check sum is transmitted falsified.

Once radio transmission is completed, the carrier is switched off after a waiting period of 6 msec. Then, within the acknowledgement delay time of [carrier rise time – 6 msec] an acknowledgement is expected. This acknowledgement includes a status byte which indicates whether or not data transmission was successful. From this information an acknowledgement is generated and transmitted to the twin device by procedure 3964R.

If the acknowledgement delay time passes without any reaction or the received acknowledgement is invalid, following a waiting period of t_W the above described radio transmission process is repeated for a programmable number of 1 to 11 retries. A repetition is accordingly transmission retry - 1.

In case the RF channel is busy with radio transmission, the modem re-examines radio operation after a waiting period of t_W . This procedure is repeated until the RF channel is idle and radio transmission can be carried out. Only the actual radio transmission is recognized as transmission retry.

$$t_W = 2^V \times t_R$$

- ♦ t_W : Waiting period
- ♦ V: Random number between 1 and 5
- ♦ t_R : Carrier Rise Time (6 to 30 msec)

During waiting period t_W the receiver is permanently monitored and a recognized data packet received. If the data packet is meant for this user, output via procedure 3964R is generated. Then the waiting period is continued.

In case all transmission retries are unsuccessful, the twin device is informed of this fact through a corresponding acknowledgement.

3.3.12.2 Broadcast Transmission

Broadcast transmission is possible from both, the radio central and each individual modem by simply using address `zero`.

Once address `zero` was recognized, a check of whether or not the RF channel is currently used for radio transmission is carried out. If this is not the case, the carrier is switched on and following the (programmable) carrier rise time (6 to 30 msec) radio transmission is started. In case procedure 3964R detects an error during the running transmission, this is reported to the program and the radio transmission is interrupted. In order to avoid processing of the already transmitted data, the data packet's check sum is falsified. Once radio transmission has been completed, the carrier is switched off following the waiting period of 6 msec.

If the RF channel is busy, the modem checks it again after the waiting period t_W . This procedure is repeated until the RF channel is idle and radio transmission can be carried out.

During waiting period t_W the receiver is monitored and a recognized data packet received. In case the data packet is meant for this user, it is output by procedure 3964R. Then the waiting period is continued.

No acknowledgement is output to the twin device.

3.3.13 Radio Reception

3.3.13.1 Reception of Addressed Data Packets

Once a radio signal has been recognized, the data packet is received up to its address. If the address is invalid, the packet is completely received and the data stored in a buffer. The very last character indicates the check sum, which is compared to the internally calculated check sum. If these check sums are not identical, the data packet is chopped.

If the check sums are correct, the carrier is switched on, time measurement for the programmable carrier rise time (6 to 30 msec) is activated and the sequential number of the packet checked.

In case the sequential number is not equal to the one of the last received data packet, the data packet is output by procedure 3964R. The procedure returns a status byte that indicates whether or not output was successful, which is included in the acknowledgement packet.

In case the sequential number is identical to the one previously received, a data packet was duplicated and the status byte of the previous transaction is included in the acknowledgement packet.

Once the carrier rise time has passed, the acknowledgement is being transmitted. When this process is completed and following a waiting period of 6 msec, the carrier is switched off.

3.3.13.2 Central Transmits Broadcast Packets

Once a radio signal has been recognized, the data packet is received up to its address. If the address is zero, the packet is completely received and the data stored in a buffer. The very last character indicates the check sum which compared to the internally calculated check sum. In case the check sum is incorrect, the data packet is chopped. If the check sums are correct, the data packet is output by procedure 3964R.

Whenever broadcast packets are transmitted, only one attempt is made.

3.3.13.3 Participants Transmit Broadcast Packets

Just like the central, any participants are able to transmit data packets to address zero. In this case no acknowledgement is expected.

This way the participant temporarily becomes the central even though it cannot transmit data to a certain other participant.

Data is output twice at the receiving modem if an antenna multiplexer is connected to the transmitting participant and the data is repeated via all antennas.

3.3.14 Block Numbering (CRC Test Method)

In order to avoid duplication of data packets during internal transmission retries, each packet is assigned a sequential number. Once the modem has been switched on, the sequential number of the first data packet to be transmitted is 80_{hex}. For any following data packet the sequential number is increased by one up to FF_{hex}. Then, following the value FF_{hex} the next value will be 81_{hex}. 80_{hex} is not used again.

Since the central is the only modem that is able to communicate with other participants by address, it manages separate numbering for each participant.

CRC Test Method

A CRC test method is applied during radio transmission, which operates table oriented and has the following parameters:

- 16 bit CRC
- Polynomial 1021_{hex}
- Initialization value $FFFF_{hex}$

3.3.15 Data Packet Structure (not visible for user)

3.3.15.1 Data Packets

Structure of data packets is related to packet structure used by procedure 3964R. This has the advantage, that at the beginning of a transmission the length of the packet does not yet have to be known and the transmission may be interrupted at any point.

Data packets received and/or transmitted wireless are constructed as follows:

Packet Section	Assigned Values
Sequential Number	80_{hex} to FF_{hex}
Address	Address of participant (0 to $7F_{hex}$)
Data	Useful data (0 to 1024 byte plus 1 byte per DLE)
DLE	Control character 10_{hex}
ETX	Control character 03_{hex}
Check sum	CRC-16 of completed packet

Table 18 Structure of data packets

3.3.15.2 Acknowledgement Packets

Acknowledgement packets received and/or transmitted wireless are constructed as follows:

Packet Section	Assigned Values
Address	Address of participant (1 to $7F_{hex}$)
Status	Status of data output (0 and 2 to 8)
Check sum	CRC-16 of address and status

Table 19 Structure of acknowledgement packets

3.3.16 Antenna Multiplexer (Antenna Diversity)

If an antenna multiplexer is included in the system, the modem is always connected to only one of several antennas via an electronic selector switch. Thus interferences are eliminated. Insertion loss of the antenna switches is usually very small (< 0.5 dB), and thus almost the full range of transmission power and sensitivity can be utilized.

The system has to be informed of the number of connected antennas through a special control block (also refer to Table 15 on page 28).

3.3.16.1 Transmission

Up front it is not clear which of the antennas is to be used for best communication with a certain participant. In case of AGV applications, the system computer usually knows where a certain participant is located. With hand held terminals for people this is not possible. The following solutions are suggested in this case:

List of Connections (implemented)

- A list of which participant was last reached via which antenna is maintained in the computer of the central radio modem. A transmission would then first be carried out via this antenna. If this communication attempt fails, following a certain algorithm the system switches to a different antenna.

Spread Priorities (not implemented)

- An antenna is assigned a high priority. A transmission attempt would then first be carried out via this priority antenna. If this transmission fails, the system switches to an other antenna following an algorithm that is yet to be determined.

3.3.16.2 Reception

Most of the time central as well as mobile participant are in reception mode and wait for an RF carrier to be detected and that data is transmitted via the serial interface. During this period the antennas are permanently polled, and each time the field strength signal RSSI is evaluated for a millisecond. If the detected value is higher than the set limit, an other cycle is polled during which the antenna with the maximum field intensity (RSSI) is selected. This antenna is then used for the data communication.

3.3.16.3 Participant Management

At a defined place within the data block of our implementation of the 3964R protocol (2. character) the coded address of the communication partner is included in order to be able to address a certain participant directly. Thus the central is able to record in a table which participant was contacted via which antenna. In case of spontaneous transmission, the transmission attempt is first done via this antenna. In contrast, the acknowledgement of a data packet from one of the participants is transmitted via the antenna determined by the reception polling. The table is designed for 20 participants and includes in addition to the antenna the current reception field intensity (RSSI value). On request, data of a participant may be output in a control block.

3.3.16.4 Broadcast Data Packet

Data packet `zero` from the central can in polling be transmitted via all antennas. This will of course cause multiple reception by participants which are located within the range of more than one antenna. However, multiple output to the vehicle computer is eliminated by the sequential numbers.

3.3.16.5 Physical Connection to Antenna Multiplexer

The antenna number is binary encoded and output via connections `AM0` and `AM1` at CMOS level.

4 Accessories

In addition to the usually available accessories like antenna, cable, connector, etc. other components are available for expanding and supplementing the system.

4.1 Wall Cabinet including Power Supply (HG 761)

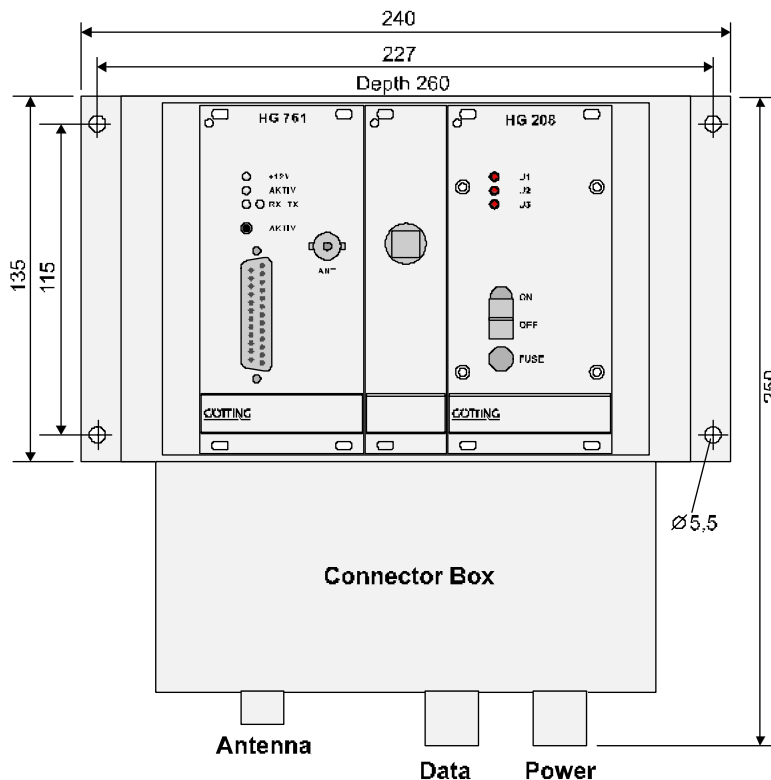

Figure 8 Front view of wall cabinet

4.2 Interface Multiplexer HG 04330

Interface multiplexer HG 04330 may be installed either as software for a PC or directly on a PC. This PC has to have four serial interfaces with FIFO module 16550. The PC communicates with the host via one of the serial interfaces. Up to three fixed stations may be connected to the remaining interfaces. This enables either covering large areas with one frequency or covering smaller areas with several frequencies, and thus the communication of a large number of participants. The software includes automatic handover (forwarding) of mobile participants between fixed stations. Short, cyclic (duration of cycle adjustable) indicating telegrams maintain this inscription/cancellation procedure even during the periods of no data transmission. These transactions can be observed on the PC screen.

As an option it is possible to equip the PC with an Ethernet card for control of the wireless communication system by an existing Ethernet. In this case it is possible to control four fixed stations. It is planned to extend this to up to eight fixed stations. There is an outline description of multiplexer operation and handover in chapter 5.2 „Measuring Point Management, Automation, Logistics, PDA“ on page 41.

5 Applications

The following few paragraphs show examples for possible applications.

5.1 Simple Point-to-Point Data Transmission or Bus Topology with Master-Slave Operation

In this application, the radio modems are more or less just replacement for a wire connection (Figure 9). Like in case of a cable, transmission is only possible in one direction at a time. It is done in simplex operation and is basically transparent except for the handshaking. It is important to pay attention to the fact, that any radio modem located within range of the transmitting modem will output the received data.

ATTENTION! Radio operation by itself is **not** a full replacement for cable connection! Errors that can only be recognized by a higher protocol may occur.

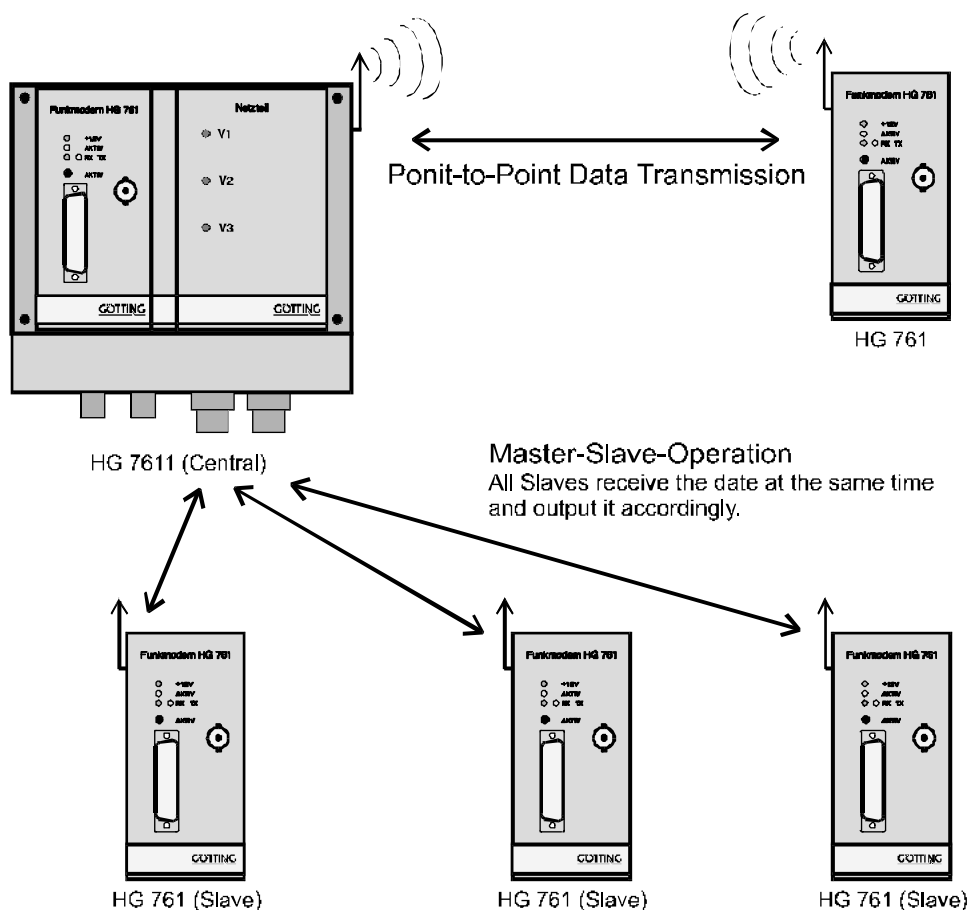

Figure 9 Simple Point-to-Point data transmission and bus topology with Master-Slave operation

5.2 Measuring Point Management, Automation, Logistics, PDA

1. Data transmission from and to separate measuring points.
In this application several participants (measuring points) are initialized and polled from one central. The device address of the central radio modem is set to 0, while addresses of the other participants are in the range of 1 to 20.
At the beginning of a measuring cycle the central activates a synchronous start of the measuring of all participants through a broadcast telegram. Then the central polls each participant separately and, if necessary, changes its configuration. At the end all participants are deactivated by the central through an second broadcast telegram.
2. Automatic control engineering and storing logistics including production data acquisition (PDA).
Compatibility of the air interface enables at the same time wireless data communication with vehicles, operating terminals on forklift trucks and handheld terminals. It is possible to manage up to 127 participants within one network. Using a multiplexer (for connecting several fixed stations) it is possible to extend the system for coverage of larger areas.

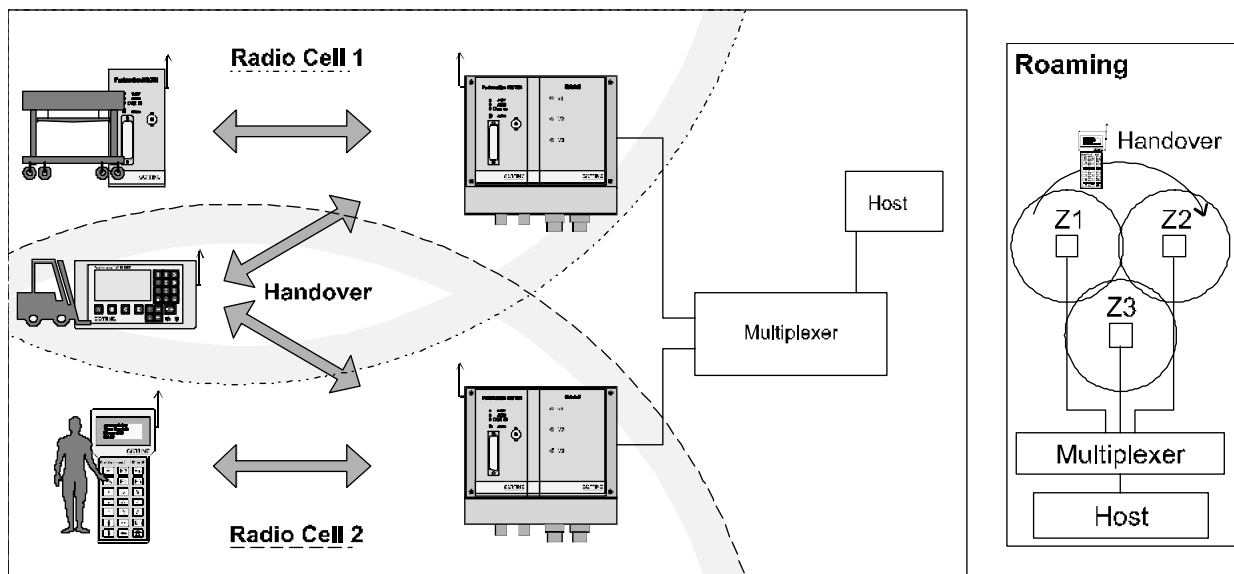

Figure 10 Interface multiplexer / Handover principle

It is possible to use interface multiplexer HG 04330 which is included in the accessories for multiplexing (also refer to chapter 4.2 on page 39). It enables creating radio cells and handover operation.

6 Appendix

A Pin Configurations Terminal Block including Multiplexer

Terminal Block					Multiplexer (Hirschmann Socket)
Pin No.	39720AA – RS232	39720AA – TTY	39720CA – RS232	39720CA – TTY	Pin No.
1	Data input TXD	Data input current drain a	Data input TXD	Data input current drain a	
2	Data output RXD	Data output current drain b	Data output RXD	Data output current drain b	
3	RTS	Data output current drain a	GND	Data output current drain a	
4	CTS	Data output current drain b		Data output current drain b	
5	DCD	RTS input current drain a	GND	GND	3
6	DSR	RTS input current drain a	+12 V	+12 V	4
7	GND	DCD output current drain a	AM 0	AM 0	1
8		DCD output current drain b	AM 1	AM 1	2
9	Signal GND	Signal GND	Signal GND	Signal GND	
10	+ 12 Volt DC	+ 12 Volt DC	+ 12 Volt DC	+ 12 Volt DC	
L1	230 V	230 V	230 V	230 V	
N	230 V	230 V	230 V	230 V	
PE	Protective earth conductor	Protective earth conductor	Protective earth conductor	Protective earth conductor	

Table 20 Pin Configurations Terminal Block including Multiplexer

B Frequency Allocations

B.1 Frequency Range 0 (ISM Range)

S0 Register	Frequency [MHz]	S0 Register	Frequency [MHz]
0	433,150	32	433,975
1	433,175	33	434,000
2	433,200	34	434,025

Table 21 Frequency Allocations: Frequency Range 0 (ISM Range) (part 1 of 2)

S0 Register	Frequency [MHz]	S0 Register	Frequency [MHz]
3	433,225	35	434,050
4	433,250	36	434,075
5	433,275	37	434,100
6	433,300	38	434,125
7	433,325	39	434,150
8	433,350	40	434,175
9	433,375	41	434,200
10	433,400	42	434,225
11	433,425	43	434,250
12	433,450	44	434,275
13	433,475	45	434,300
14	433,500	46	434,325
15	433,525	47	434,350
16	433,550	48	434,375
17	433,575	49	434,400
18	433,600	50	434,425
19	433,625	51	434,450
20	433,650	52	434,475
21	433,675	53	434,500
22	433,700	54	434,525
23	433,725	55	434,550
24	433,750	56	434,575
25	433,775	57	434,600
26	433,800	58	434,625
27	433,825	59	434,650
28	433,850	60	434,675
29	433,875	61	434,700
30	433,900	62	434,725
31	433,950	63	434,750

Table 21 Frequency Allocations: Frequency Range 0 (ISM Range) (part 2 of 2)

B.2 Frequency Range 1 (ABIN Range)

S0 Register	Frequency [MHz]	S0 Register	Frequency [MHz]
0	456,200	8	456,280
1	456,210	9	456,290
2	456,220	10	456,300
3	456,230	11	456,310
4	456,240	12	456,320
5	456,250	13	456,330
6	456,260	14	456,340
7	456,270	15	456,350

Table 22 Frequency Allocations: Frequency Range 1 (ABIN Range)

B.3 Frequency Range 2 (Brazil)

414,000 to 415,975 MHz:

$$n = (414 + n \times 0,025)\text{MHz with } 0 \leq n \leq 79$$

B.4 Frequency Range 3 (ABIN Range)

S0 Register	Frequency [MHz]	S0 Register	Frequency [MHz]
0	466,200	8	466,280
1	466,210	9	466,290
2	466,220	10	466,300
3	466,230	11	466,310
4	466,240	12	466,320
5	466,250	13	466,330
6	466,260	14	466,340
7	466,270	15	466,350

Table 23 Frequency Allocations: Frequency Range 3 (ABIN Range)

C Pin Configuration of 7pin Flange Socket

C.1 for RS 232 (V.24)

Pin	Function (RS 232)	Description	Remark
1			
2	TxD	Output	
3			
4	RxD	Input	
5	Signal GND		
6	GND	Data and Power Supply GND	Bridged with 3pin Flange Connector Pin 3
7	+UB		Bridged with 3pin Flange Connector Pin 2

Table 24 Pin Configuration of 7pin Flange Socket for RS 232 (V.24)

C.2 for 20 mA Current Loop (TTY) or RS 422

Pin	Function (RS 232)	Description	Remark
1	TxD-	Output	
2	TxD+	Output	
3	RxD-	Input	
4	RxD+	Input	
5	Signal GND		
6	GND	Data and Power Supply GND	Bridged with 3pin Flange Connector Pin 3
7	+UB		Bridged with 3pin Flange Connector Pin 2

Table 25 Pin Configuration of 7pin Flange Socket for 20 mA Current Loop (TTY) or RS 422

D Pin Configuration of 3pin Flange Connector**Power Supply**

Pin	Function (RS 232)	Description	Remark
1	GND	Data and Power Supply GND	Bridged with 7pin Flange Socket Pin 6
2	+UB		Bridged with 7pin Flange Socket Pin 7
3	NC		

Table 26 Pin Configuration of 3pin Flange Connector

E Pin Configuration of VG Blade Terminal

E.1 for RS 232 Interface

	VG Blade Terminal Type C – 64pin (RF contact on front panel)		VG Blade Terminal Type C – 32pin (RF contact on front panel)	
	a	c	a	c
1	N.C.	N.C.		
2	+Ub	+Ub	+Ub	+Ub
3	N.C.	N.C.		
4	Relay Make Contact	Relay Make Contact	Relay Make Contact	Relay Make Contact
5	N.C.	N.C.		
6	Relay Break Contact	Relay Break Contact	Relay Break Contact	Relay Break Contact
7	N.C.	N.C.		
8	Rel. Center Contact	Rel. Center Contact	Rel. Center Contact	Rel. Center Contact
9	N.C.	N.C.		
10	+Ub	+Ub	+Ub	+Ub
11	+12 V out	N.C.		
12	AM 0	AM 1	AM 0	AM 1
13	+Ub	+Ub		
14	CTS	DCD	CTS	DCD
15	Relay Center Contact	do not connect!		
16	do not connect!	TD	do not connect!	TD
17	Relay Break Contact	do not connect!		
18	do not connect!	RTS	do not connect!	RTS
19	Relay Make Contact	do not connect!		
20	DSR	RD	DSR	RD
21	standby	N.C.		
22	Signal GND	Signal GND	Signal GND	Signal GND
23	Power Supply GND	Power Supply GND		
24	Power Supply GND	Power Supply GND	Power Supply GND	Power Supply GND
25	N.C.	N.C.		
26	FS 2	FS 1	FS 2	FS 1
27	N.C.	N.C.		
28	FS 4	FS 3	FS 4	FS 3
29	N.C.	N.C.		
30	Signal GND	Signal GND	Signal GND	Signal GND
31	Signal GND	Signal GND		
32	Signal GND	Signal GND	Signal GND	Signal GND

Table 27 Pin Configuration of VG Blade Terminal for RS 232 Interface

E.2 for TTY Interface

	VG Blade Terminal Type C – 64pin (RF contact on front panel)		VG Blade Terminal Type C – 32pin (RF contact on front panel)	
	a	c	a	c
1	N.C.	N.C.		
2	+Ub	+Ub	+Ub	+Ub
3	N.C.	N.C.		
4	Relay Make Contact	Relay Make Contact	Relay Make Contact	Relay Make Contact
5	N.C.	N.C.		
6	Relay Break Contact	Relay Break Contact	Relay Break Contact	Relay Break Contact
7	N.C.	N.C.		
8	Relay Center Contact	Relay Center Contact	Relay Center Contact	Relay Center Contact
9	N.C.	N.C.		
10	+Ub	+Ub	+Ub	+Ub
11	+12 V out	N.C.		
12	AM 0	AM 1	AM 0	AM 1
13	+Ub	+Ub		
14	DCD TTY b	DCD TTY a	DCD TTY b	DCD TTY a
15	Relay Center Contact	do not connect!		
16	TD TTY b	TD TTY a	TD TTY b	TD TTY a
17	Relay Break Contact	do not connect!		
18	RTS TTY b	RTS TTY b	RTS TTY b	RTS TTY a
19	Relay Make Contact	do not connect!		
20	RD TTY b	RD TTY a	RD TTY b	RD TTY a
21	standby	N.C.		
22	Signal GND	Signal GND	Signal GND	Signal GND
23	Power Supply GND	Power Supply GND		
24	Power Supply GND	Power Supply GND	Power Supply GND	Power Supply GND
25	N.C.	N.C.		
26	FS 2	FS 1	FS 2	FS 1
27	N.C.	N.C.		
28	FS 4	FS 3	FS 4	FS 3
29	N.C.	N.C.		
30	Signal GND	Signal GND	Signal GND	Signal GND
31	Signal GND	Signal GND		
32	Signal GND	Signal GND	Signal GND	Signal GND

Table 28 Pin Configuration of VG Blade Terminal for TTY Interface

E.3 for RS 485 Interface

	VG Blade Terminal Type C – 64pin (RF contact on front panel)		VG Blade Connector Type C – 32pin (RF contact on front panel)	
	a	c	a	c
1	N.C.	N.C.		
2	+Ub	+Ub	+Ub	+Ub
3	N.C.	N.C.		
4	Relay Make Contact	Relay Make Contact	Relay Make Contact	Relay Make Contact
5	N.C.	N.C.		
6	Relay Break Contact	Relay Break Contact	Relay Break Contact	Relay Break Contact
7	N.C.	N.C.		
8	Relay Center Contact	Relay Center Contact	Relay Center Contact	Relay Center Contact
9	N.C.	N.C.		
10	+Ub	+Ub	+Ub	+Ub
11	+12 V out	N.C.		
12	AM 0	AM 1	AM 0	AM 1
13	+Ub	+Ub		
14	do not connect!	do not connect!	do not connect!	do not connect!
15	Relay Center Contact	do not connect!		
16	do not connect!	BUS-A	do not connect!	BUS-A
17	Relay Break Contact	do not connect!		
18	do not connect!	do not connect!	do not connect!	do not connect!
19	Relay Make Contact	do not connect!		
20	do not connect!	BUS-B	do not connect!	BUS-B
21	standby	N.C.		
22	Signal GND	Signal GND	Signal GND	Signal GND
23	Power Supply GND	Power Supply GND		
24	Power Supply GND	Power Supply GND	Power Supply GND	Power Supply GND
25	N.C.	N.C.		
26	FS 2	FS 1	FS 2	FS 1
27	N.C.	N.C.		
28	FS 4	FS 3	FS 4	FS 3
29	N.C.	N.C.		
30	Signal GND	Signal GND	Signal GND	Signal GND
31	Signal GND	Signal GND		
32	Signal GND	Signal GND	Signal GND	Signal GND

Table 29 Pin Configuration of VG Blade Terminal for RS 485 Interface

F Pin Configuration of 25pin Sub-D Socket

	RS 232	TTY	RS 485
1	GND	GND	GND
2	TD	D1 (TD) TTY a	BUS-A
3	RD	D2 (RD) TTY a	BUS-B
4	RTS	S2 (RTS) TTY a	do not connect!
5	CTS	M2	do not connect!
6	DSR	M1	do not connect!
7	GND	E2 (GND)	GND
8	DCD	M5 (DCD) TTY a	do not connect!
9	N.C.	N.C.	N.C.
10	AM 0	Am 0	AM 0
11	AM 1	AM 1	AM 1
12	+12 V	+12 V	+12 V
13	+12 V	+12 V	+12 V
14	do not connect!	D1 (TD) TTY b	do not connect!
15	Relay Center Contact	D2 (RD) TTY b	do not connect!
16	do not connect!	S2 (RTS) TTY b	do not connect!
17	N.C.	N.C.	N.C.
18	standby*	standby*	standby*
19	do not connect!	M5 (DCD) TTY b	do not connect!
20	DTR	N.C.	N.C.
21	+UB*	+UB*	+UB*
22	Relay Break Contact*	Relay Break Contact*	Relay Break Contact*
23	Power Supply GND*	Power Supply GND*	Power Supply GND*
24	Relay Make Contact*	Relay Make Contact*	Relay Make Contact*
25	Relay Center Contact*	Relay Center Contact*	Relay Center Contact*
	* bondable		

Table 30 Pin Configuration of 25pin Sub-D Socket

7 List of Figures

Figure 1	General System Scheme.....	6
Figure 2	Front panel elements HG 761	7
Figure 3	Operating modes of the modem's TTY interface	10
Figure 4	Setting operating modes via jumpers on TTY interface board HG 9262	10
Figure 5	Layout of the board of the radio modem	12
Figure 6	Description of logical procedure of data transmission	21
Figure 7	Schematics description of data transmission	24
Figure 8	Front view of wall cabinet.....	39
Figure 9	Simple Point-to-Point data transmission and bus topology with Mas- ter-Slave operation	40
Figure 10	Interface multiplexer / Handover principle.....	41

8 List of Tables

Table 1	Available power supply versions	8
Table 2	RS 232 signals implemented within the modem.....	8
Table 3	TTY line pairs implemented in the modem	9
Table 4	List of software revisions	13
Table 5	List of system HG 761 variants	13
Table 6	Software Variants	14
Table 7	Duration of waiting period t_p at different baud rates.....	15
Table 8	Function of bits 0 and 1 of rotary hex switch SW2.....	18
Table 9	Functions of bits 2 and 3 of rotary hex switch SW2.....	19
Table 10	Functions of bits 0, 1 and 2 of rotary hex switch SW3	19
Table 11	Interface circuits for RS 232.....	20
Table 12	Interface circuits for TTY	20
Table 13	Settings of device addresses	23
Table 14	Acknowledgement packets	27
Table 15	Implemented Control Commands (Version 3.32 and higher)	28
Table 16	Control block values while reading error status.....	32
Table 17	Control block values for activating test functions	32
Table 18	Structure of data packets.....	36
Table 19	Structure of acknowledgement packets	36
Table 20	Pin Configurations Terminal Block including Multiplexer.....	42
Table 21	Frequency Allocations: Frequency Range 0 (ISM Range)	42
Table 22	Frequency Allocations: Frequency Range 1 (ABIN Range)	44
Table 23	Frequency Allocations: Frequency Range 3 (ABIN Range)	44
Table 24	Pin Configuration of 7pin Flange Socket for RS 232 (V.24)	45
Table 25	Pin Configuration of 7pin Flange Socket for 20 mA Current Loop (TTY) or RS 422	45
Table 26	Pin Configuration of 3pin Flange Connector.....	46
Table 27	Pin Configuration of VG Blade Terminal for RS 232 Interface	47
Table 28	Pin Configuration of VG Blade Terminal for TTY Interface.....	48
Table 29	Pin Configuration of VG Blade Terminal for RS 485 Interface	49
Table 30	Pin Configuration of 25pin Sub-D Socket	50

9 Index

A

Acknowledgement Packet 26
 Acknowledgement packets 27
 analog interface 11
 antenna cable 7
 Antenna Diversity 37
 Application examples
 Data transmission from and to
 separate measuring
 points 41
 application examples 40
 Simple Point-to-Point Data
 Transmission 40
 AT command 16

C

cabling 7
 Control Commands 28

D

Data Packets 25
 DCE 6
 DIN41612 8
 DTE 6
 duplex operation 11
 Duration of waiting period tp 15

E

Echo 16

F

Frequency Allocations 42
 full duplex 22

H

half duplex 22
 Handover 31, 39, 41
 Hardware configurations 8
 HG

 04330 39, 41
 39720_AA 14
 39720_BA 22
 39720_CA 22
 754 13
 75430 30
 761 6
 761 (system variants) 13
 7611 39
 9262 9

HG 9262 9

 TTY interface plug-in module 9

I

interface 11
 Interface multiplexer 41
 interface multiplexer 39

M

Master-Slave Operation 22, 40
 microprocessor 11
 Modulation method
 GMSK 11
 Multiplexer 41, 42

P

PLC 22, 32
 Point-to-Point Data Transmission 40
 Power Supply 8

R

Radio Modem 6
 Accessories 39
 Board layout 12
 Connections 7
 Front Panel Elements 7
 LEDs 7
 Possible Connections 6
 Push buttons 7
 RS 232 8
 Allocation of Blade Terminal 47
 Voltage Interface 8
 RS 422 11
 RS 485 11
 cable length 11
 Pin Configuration of Blade
 Terminal 49
 symmetric interface 11
 RSSI values 17

S

simplex operation 6, 40
 Sinec L1 Bus 22
 software revisions 13
 Software versions
 HG 39720_AA 14
 Carrier Monitoring 21
 Implemented Interface
 Circuits 20

- Logical Procedure of Data
 - Transmission 21
- HG 39720_BA 22
- HG39720_CA 22
 - Addresses 23
 - Antenna Multiplexer 37
 - Block Numbering 35
 - CRC Test Method 36
 - Data Packet Structure 36
 - Radio Reception 35
 - Radio Transmission 33
 - Receiving with Procedure
 - 3964R 26
 - Schematic Procedure of Data
 - Transm. 24
 - Software update 22
 - Structure of Data Packets 26
 - Transmission Rates and Interface
 - Connections 22
 - Transmitting via Procedure
 - 3964R 25
- Sub-D Socket 50
 - Pin Configuration 50
- System Description 6
- T
 - Terminal Block 42
 - Test functions 17
 - transceiver 11
 - TTY 9
 - 20mA Current Interface 9
 - Interface 9
 - operating modes 9
 - Pin Configuration of Blade
 - Terminal 48
- V
 - Variants 13